

TO-220 3-Lead Package Outline (Flow 34)
 (Reference LTC DWG # 05-08-1494)

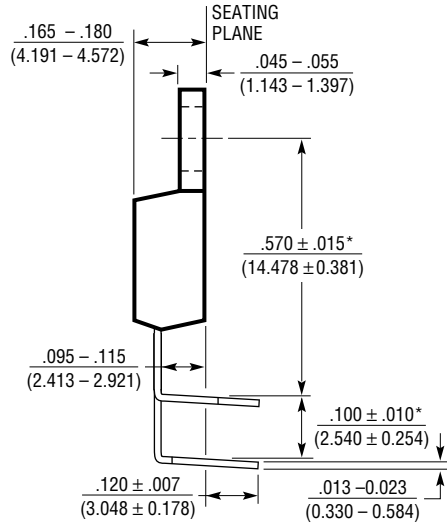
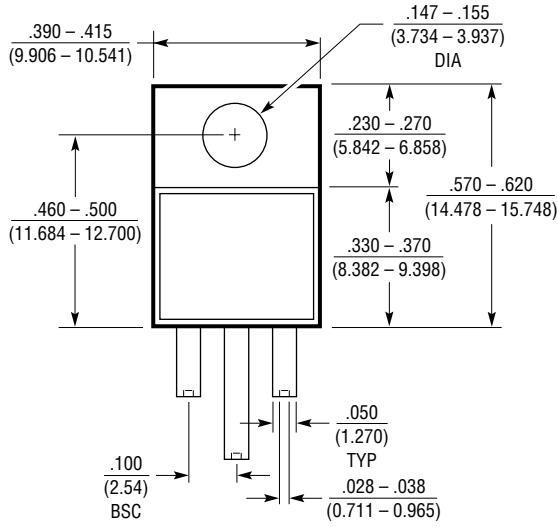

* MEASURED AT SEATING PLANE
 CONTROLLING DIMENSIONS ARE IN INCHES

T3 (TO-220)(FLOW 34) 0801